

vision

ficha técnica

datasheet



ref. 5551929

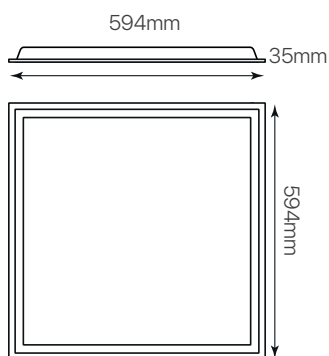
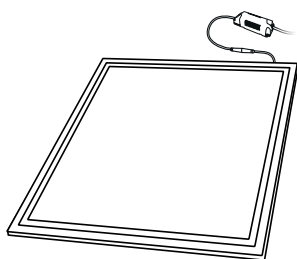

585mm x 585mm

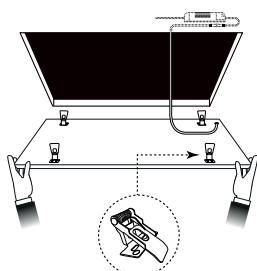

opcional **x4**

Nombre / Name	Vision
Referencia / Reference	5551929
Materiales / Materials	Metal + Aluminio / Steel + Aluminium
Difusor / Diffuser	PS
Potencia / Power	40W
Temperatura de color / Color temperature	5700K
Flujo luminoso / Luminous flux	4089lm
Dimable / Dimmable	Opcional (consultar) / Optional (please inquire)
Ángulo de apertura / Beam angle	120°
Ángulo de detección / Detection angle	-
Flicker Free	Sí / Yes
IP	20
IK	03
F.P.	0.9
UGR	≤19
IRC	>80
Chip	PHILIPS 2835 SMD
Driver	LIFUD
Vida media (duración) / Average life	± 30.000h
Clase energética / Energy class	F
Aislamiento eléctrico / Electrical isolation	Clase II / Class II
Colores / Colors	Blanco / White
Medida exterior / Product size	594mm x 594mm x 35mm
Medidas de corte / Cutting measurements	585mm x 585mm
Tª (ambiente/trabajo) / Tª (environment/work)	-20°C ~ 40°C
Input	AC220 ~ 240V
Output	DC 36 ~ 42V 1200mA
Frecuencia / Frequency	50 / 60Hz
Peso / Weight	1,22 kg
Certificados / Certificates	CE RoHS
Garantía / Warranty	2 años / 2 years